

REV	LOCATIONS	DESCRIPTION	DATE	REVISER	APPD
1	△	Update dimensions	29/OCT/24	MATT	LEO

SPECIFICATIONS

Electrical
 Current Rating: 30A AC(rms)/DC
 Voltage Rating: 300V AC(rms)/DC
 Insulation Resistance: 500 MΩ Min./DC 500V
 Dielectric Voltage: 1600V AC /1 Min.
 Screw Torque: 0.5Nm(4.9Lb.in)
 Wire range: 24~10AWG
 Strip length: 6~7mm
 Temperature Range-Operating: -40°C~+105°C

Material and Plating
 Housing: PA66 (UL 94V-0)
 Contacts: Copper alloy/ Tin plated
 Cage: Brass/ Nickel plated
 Screw: M3.5 Steel/ Zinc plated

Ordering Information

FTB 762 02 - F XX B 2 GN B
 1 2 3 4 5 6 7 8 9

1 Category FTB-Terminal Block	2 Series Number 762-Pitch 7.62mm	3 Distinction No. 02	4 Type F-Female
5 Circuits XX	6 Entry Angle B-90° Angle	7 Material-Resin 2-PA66	8 Color-Resin GN-Green
		9 Packaging B-PE Bag	

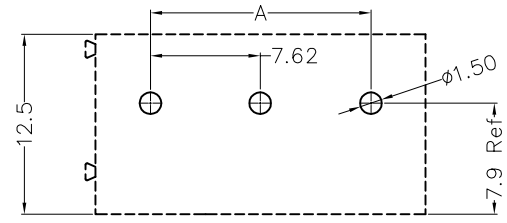
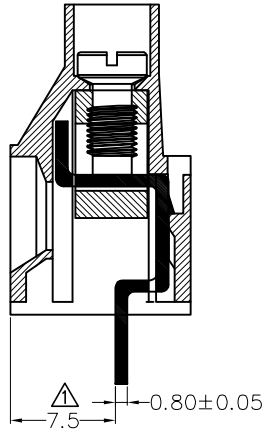
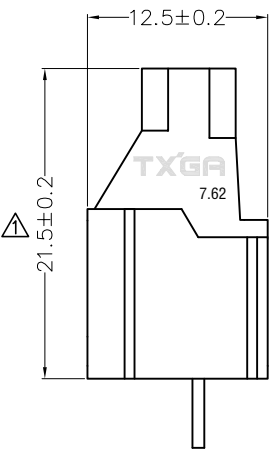
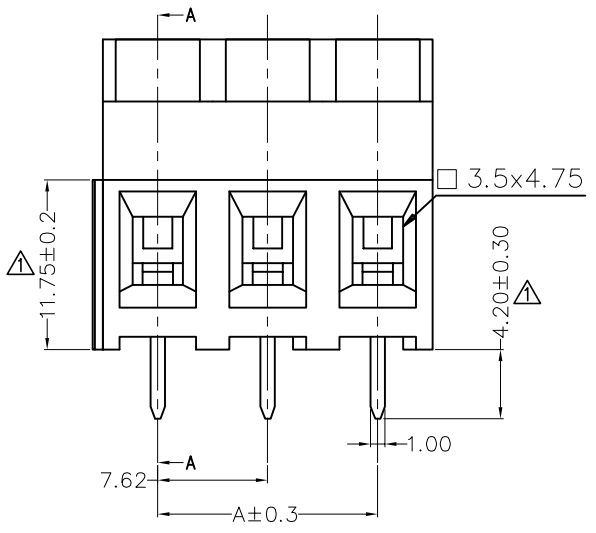
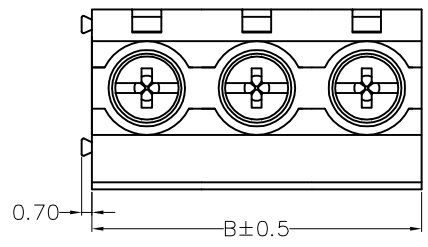

Recommended P.C.Board Layout

 THIRD ANGLE PROJECTION	GENERAL TOLERANCES (UNLESS SPECIFIED)		APPROVE BY LEO	DATE 23/FEB/24	PART NO. FTB76202-FXXB2GNB	ITEM NO. FTB76202	 Building Technology Cornerstone
	X. ±0.30	X.* ±5°	CHECKED BY GISELLE	DATE 23/FEB/24	TITLE Terminal Block Pitch 7.62mm 90° Angle		
DESIGN UNITS METRIC(mm)	X.X ±0.20	X.X* ±2°	DRAWN BY MATT	DATE 23/FEB/24	THIS DRAWING CONTAINS INFORMATION THAT IS PROPRIETARY TO TXGA INDUSTRIAL ELECTRONICS(S.Z)CO.,LTD AND SHOULD NOT BE USED WITHOUT WRITTEN PERMISSION		
SCALE 5:1	SIZE A4	X.XX ±0.15	X.XX* ±1°				
		X.XXX ±0.10	X.XXX* ±0.5°				

1 2 3 4 5 6 7 8

REV	LOCATIONS	DESCRIPTION	DATE	REVISER	APPD

A

A

B

B

C

C

D

D



E

E

F

F

Circuits (n)	Part No.	Dimensions (mm)		Circuits (n)	Part No.	Dimensions (mm)	
		A	B			A	B
2	FTB76202-F02B2GNB	7.62	15.24	14	FTB76202-F14B2GNB	99.06	106.68
3	FTB76202-F03B2GNB	15.24	22.86	15	FTB76202-F15B2GNB	106.68	114.30
4	FTB76202-F04B2GNB	22.86	30.48	16	FTB76202-F16B2GNB	114.30	121.92
5	FTB76202-F05B2GNB	30.48	38.10	17	FTB76202-F17B2GNB	121.92	129.54
6	FTB76202-F06B2GNB	38.10	45.72	18	FTB76202-F18B2GNB	129.54	137.16
7	FTB76202-F07B2GNB	45.72	53.34	19	FTB76202-F19B2GNB	137.16	144.78
8	FTB76202-F08B2GNB	53.34	60.96	20	FTB76202-F20B2GNB	144.78	152.40
9	FTB76202-F09B2GNB	60.96	68.58	21	FTB76202-F21B2GNB	152.40	160.02
10	FTB76202-F10B2GNB	68.58	76.20	22	FTB76202-F22B2GNB	160.02	167.64
11	FTB76202-F11B2GNB	76.20	83.82	23	FTB76202-F23B2GNB	167.64	175.26
12	FTB76202-F12B2GNB	83.82	91.44	24	FTB76202-F24B2GNB	175.26	182.88
13	FTB76202-F13B2GNB	91.44	99.06				0.00

 THIRD ANGLE PROJECTION	GENERAL TOLERANCES (UNLESS SPECIFIED)		APPROVE BY	DATE	PART NO.	ITEM NO.	 Building Technology Cornerstone	
	X. ±0.30	X.* ±5°	LEO	23/FEB/24	FTB76202-FXXB2GNB	FTB76202		
	DESIGN UNITS METRIC(mm)	X.X ±0.20	X.X* ±2°	CHECKED BY	DATE	TITLE		REV 1
	SCALE 5:1	X.XX ±0.15	X.XX* ±1°			Terminal Block Pitch 7.62mm 90° Angle		SHEET NO. 2/2
SIZE A4	X.XXX ±0.10	X.XXX* ±0.5°	DRAWN BY	DATE	THIS DRAWING CONTAINS INFORMATION THAT IS PROPRIETARY TO TXGA INDUSTRIAL ELECTRONICS(S.Z)CO.,LTD AND SHOULD NOT BE USED WITHOUT WRITTEN PERMISSION			
			MATT	23/FEB/24				

1 2 3 4 5 6 7 8